



Ridder Growing Solutions B.V.  
Honderdland 131  
2676 LT  
Maasdijk

Telephone: +31(0)153620300  
E-mail: [Info@Ridder.com](mailto:Info@Ridder.com)  
Web: <http://www.Ridder.com>



Project number:  
Dealer name:  
Dealer reference:  
Dealer contact person:  
Offer subject:  
Offered by:

Machine type: Cabinet valve control [04] DC24V  
Machine series: HortiMaX-Go!  
Machine number: 20810101  
Machine nominal supply voltage: [1P85...264V+N+PE/47...63Hz]  
Machine nominal supply current:  
Machine connected load:  
Machine cos phi:  
Machine maximum pre-fuse:

Corporation name:  
Corporation address:  
Postal code:  
Domicile/city:  
Region:  
Country:  
Contact person:  
Telephone number:

Project name: 20810101EAS020 Cabinet valve control [04] DC24V  
Project status: [As Build]  
Project template: 20810101EAS011 Cabinet valve control [04] DC24V  
Project initial date: 01/01/2024  
Project designed by: MBL  
Document number: 20810101EAS020  
Page number: 1  
Number of pages: 14

Notice 1: [ETO]  
Notice 2:  
Notice 3:

NEN-EN-IEC 60204-1:2006

Color	Abbreviation	Power circuit
Black	BK	Mains voltage phase
Blue	BU	Mains voltage null
Yellow/green	YEGN	Ground [Systeem ground]
Control circuit		
Red	RD	Control circuit DC24V plus
Blue	BU	Control circuit DC24V min
White	WH	Control circuit DC24V switched
Brown	BN	Control circuit AC24V phase
Yellow	YE	Control circuit AC24V null
Grey	GY	Control circuit AC24V switched
Alarm circuit		
Orange	OG	Signaling and alarm

Wire gauge designation in [mm²]

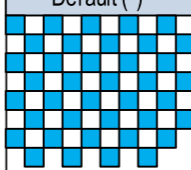
Default (-)	Originating from page	Optional (-)
		



Project file: 20810101EAS020 Cabinet valve control [04] DC24V	Project initial date: 01/01/2024	Page initial date: 01/01/2024	Symbol scale: 1:1	Page: 2
Project number: 20810101EAS020	Function (-): =Unit	Project designed by: MBL	Drawing scale: 1:1	of: 14
URL: http://www.Ridder.com	Location (+): +Main cabinet	Page revision date:		Page index:
Document number: 20810101EAS020	Product (-): -Standards	Project status: [As Build]	Page revision:	



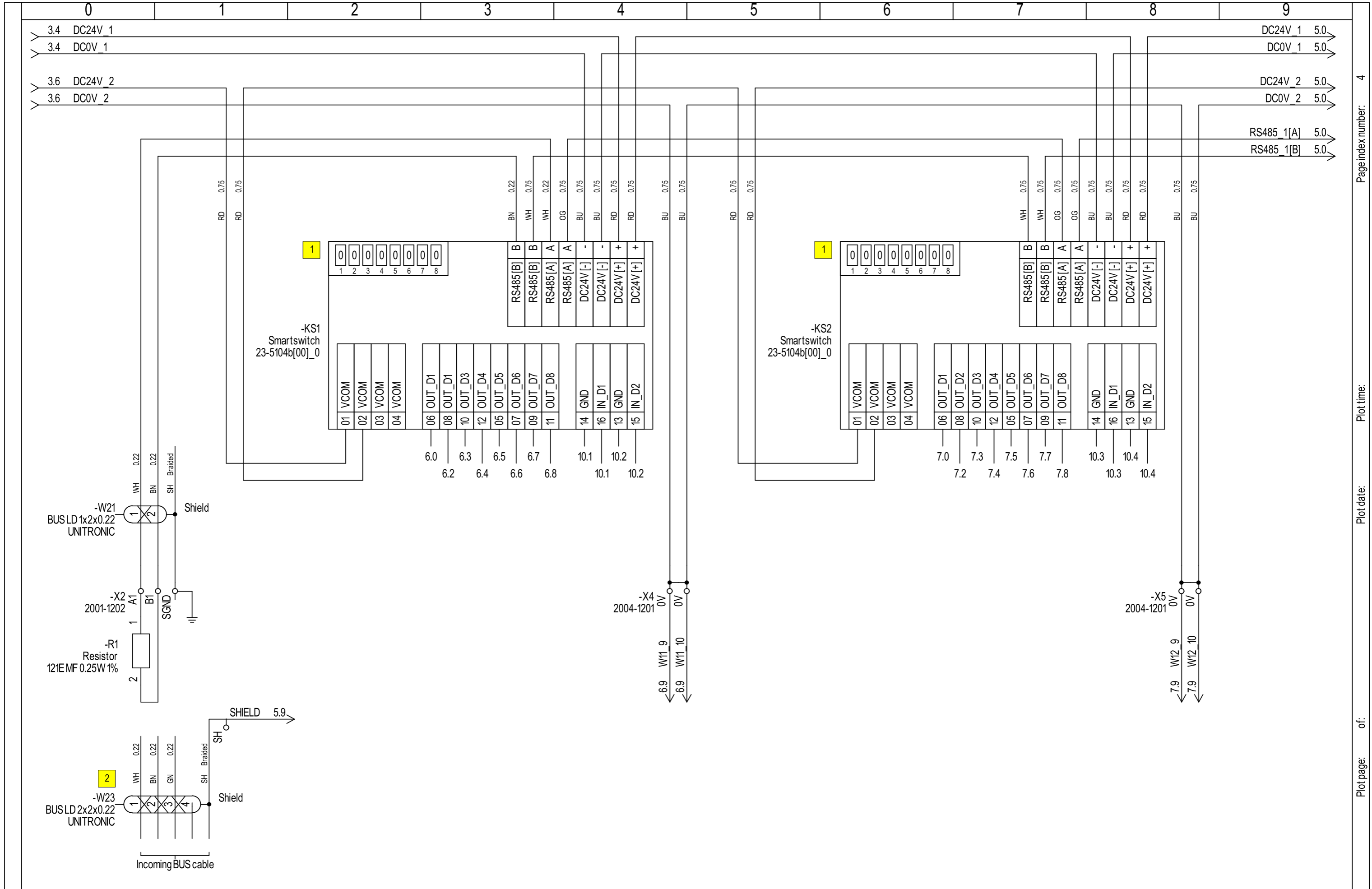

Project file:	20810101EAS020 Cabinet valve control [04] DC24V		Page initial date:	01/01/2024	Symbol scale:	1:1	Page:	4			
Project number:		Function (=):	=Unit	Project initial date:	01/01/2024	Page designed by:	MBL	Drawing scale:	1:1	of:	14
URL:	http://www.Ridder.com		Location (+):	+Main cabinet		Project designed by:	MBL		Page revision date:		Page index:
Document number:	20810101EAS020		Product (-):	-Smartswitch[KS1..KS2]		Project status:	[AsBuild]		Page revision:		

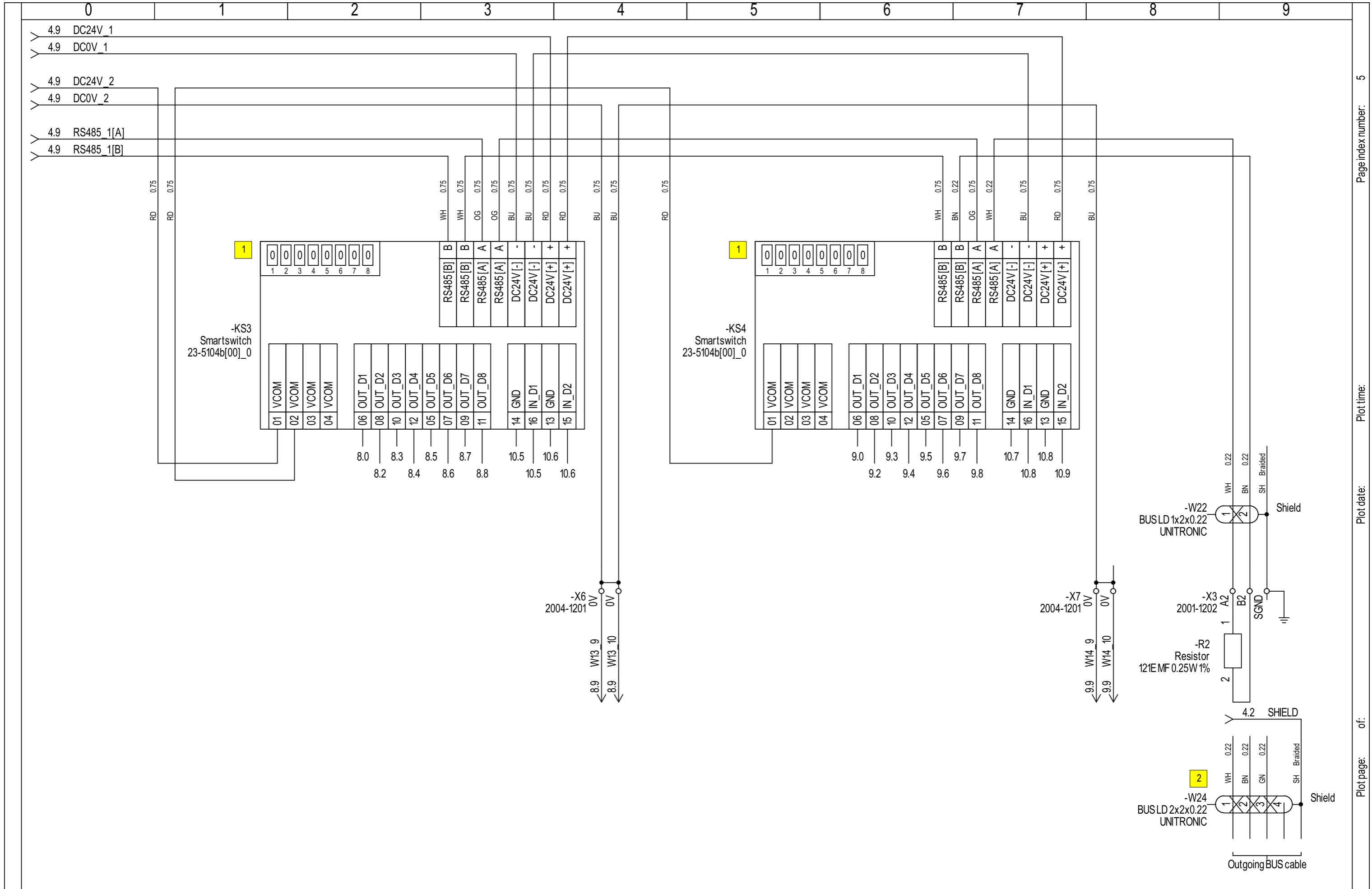

Project file:	20810101EAS020 Cabinet valve control [04] DC24V		Page initial date:	01/01/2024	Symbol scale:	1:1	Page:	5	
Project number:	Function (-):	=Unit	Project initial date:	01/01/2024	Page designed by:	MBL	Drawing scale:	1:1	
URL:	http://www.Ridder.com	Location (+):	+Main cabinet	Project designed by:	MBL	Page revision date:		of:	14
Document number:	20810101EAS020	Product (-):	-Smartswitch [KS3...KS4]	Project status:	[As Build]	Page revision:		Page index:	

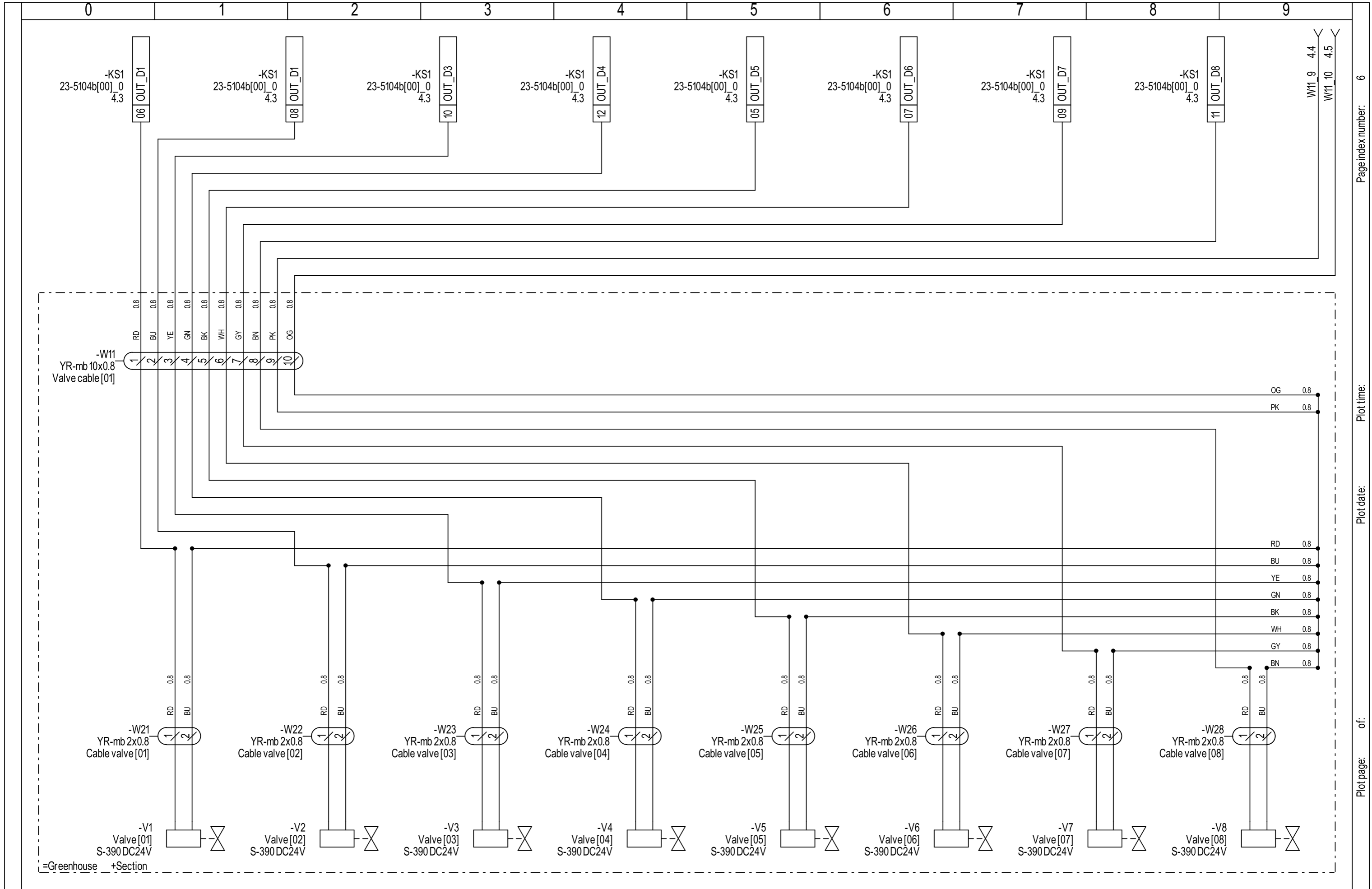

Project file:	20810101EAS020 Cabinet valve control [04] DC24V		Page initial date:	01/01/2024	Symbol scale:	1:1	Page:	6			
Project number:		Function (=):	=Unit	Project initial date:	01/01/2024	Page designed by:	MBL	Drawing scale:	1:1	of:	14
URL:	http://www.Ridder.com		Location (+):	+Main cabinet		Page revision date:		Page index:			
Document number:	20810101EAS020		Product (-):	-Valve [V1...V8]		Project status:	[AsBuild]		Page revision:		

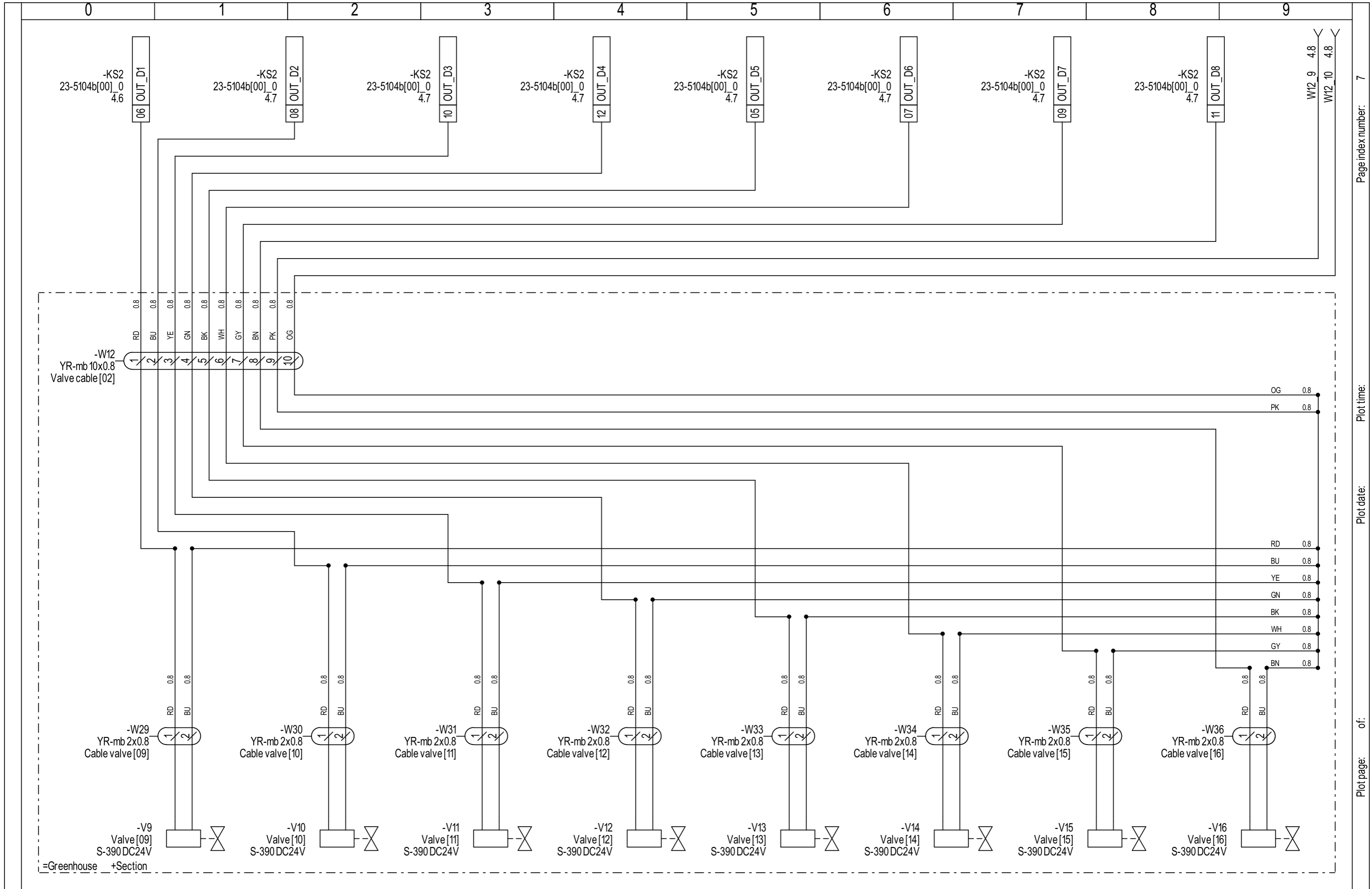

Page index number: 7

Plot time:

Plot date:

Plot page: of:



Project file:	20810101EAS020 Cabinet valve control [04] DC24V		Page initial date:	01/01/2024	Symbol scale:	1:1	Page:	7
Project number:	Function (=): =Unit		Project initial date:	01/01/2024	Page designed by:	MBL	Drawing scale:	1:1
URL:	http://www.Ridder.com		Project designed by:	MBL	Page revision date:		of:	14
Document number:	20810101EAS020		Product (-):	-Valve [V9...V16]	Page revision:		Page index:	

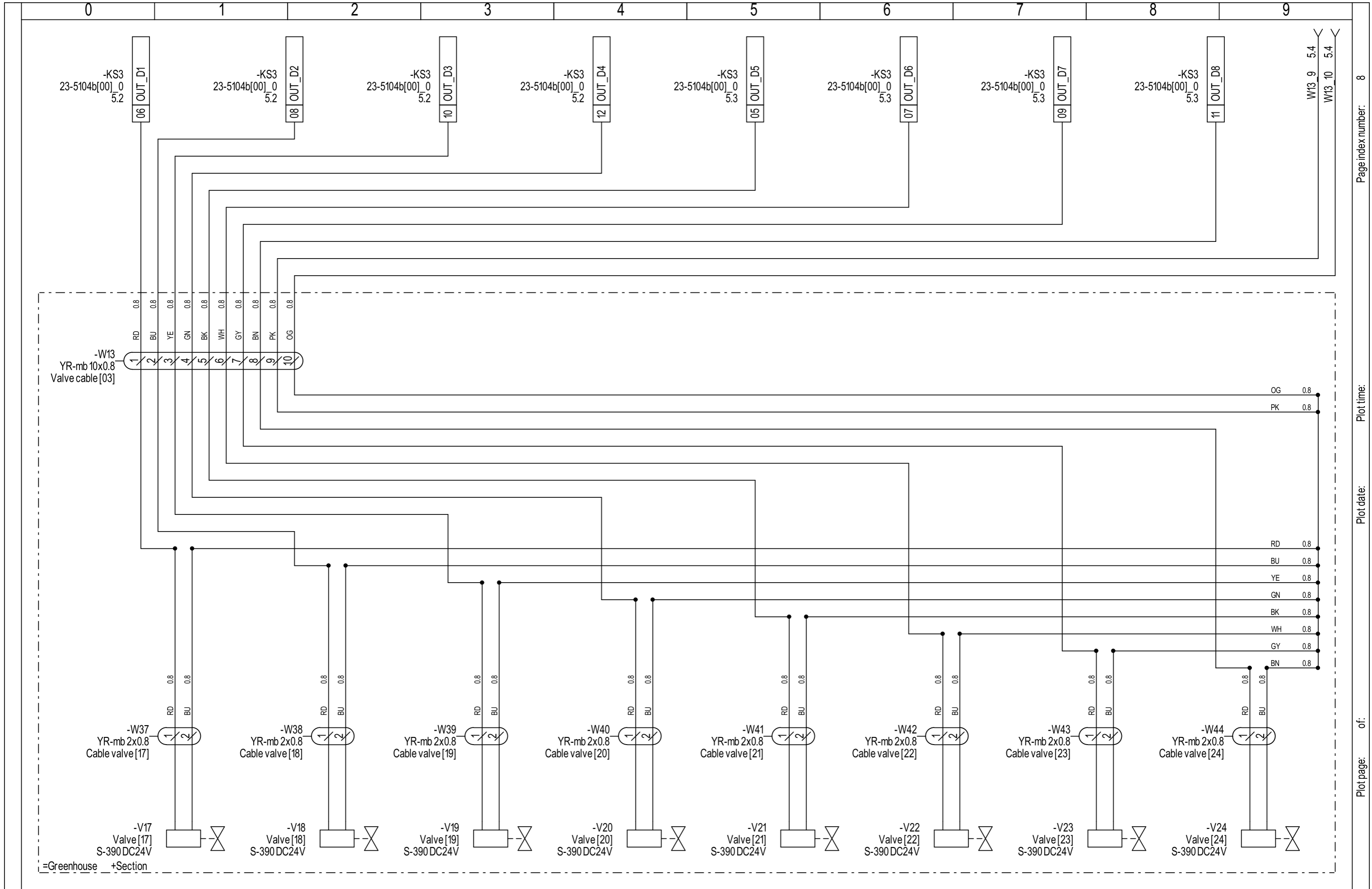

Project file:	20810101EAS020 Cabinet valve control [04] DC24V		Page initial date:	01/01/2024	Symbol scale:	1:1	Page:	8
Project number:	Function (=): =Unit		Project initial date:	01/01/2024	Page designed by:	MBL	Drawing scale:	1:1
URL:	http://www.Ridder.com		Project designed by:	MBL	Page revision date:		of:	14
Document number:	20810101EAS020		Project status:	[AsBuild]	Page revision:		Page index:	
	Location (+): +Main cabinet							
	Product (-): -Valve [V17...V24]							



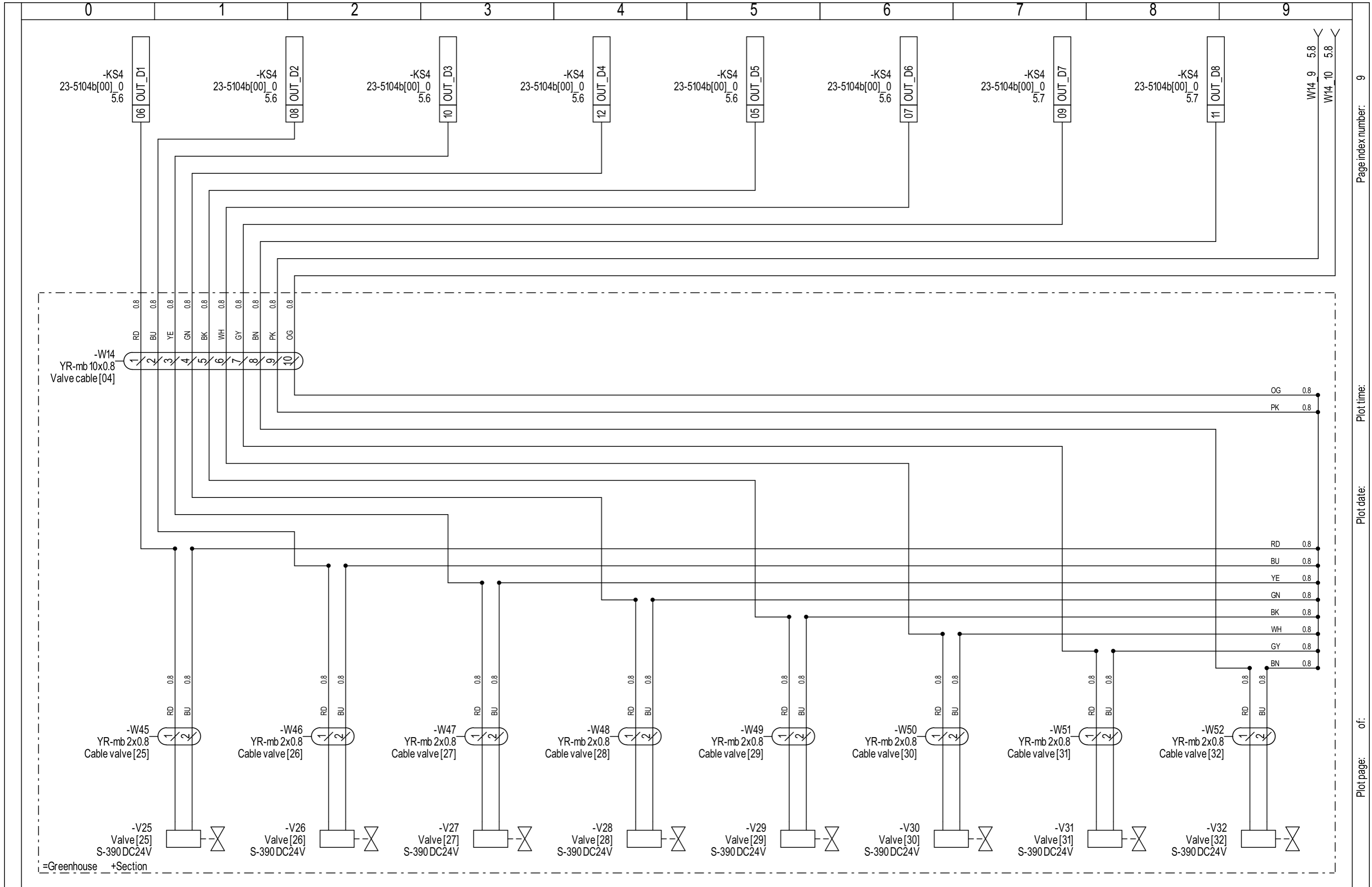

Page index number: 9

Plot time:

Plot date:

Plot page: of:



Project file:	20810101EAS020 Cabinet valve control [04] DC24V		Page initial date:	01/01/2024	Symbol scale:	1:1	Page:	9	
Project number:	Function (=): =Unit		Project initial date:	01/01/2024	Page designed by:	MBL	Drawing scale:	1:1 of: 14	
URL:	http://www.Ridder.com		Project designed by:	MBL	Page revision date:		Page index:		
Document number:	20810101EAS020		Product (-):	-Valve [V25...V32]		Project status:	[AsBuild]	Page revision:	

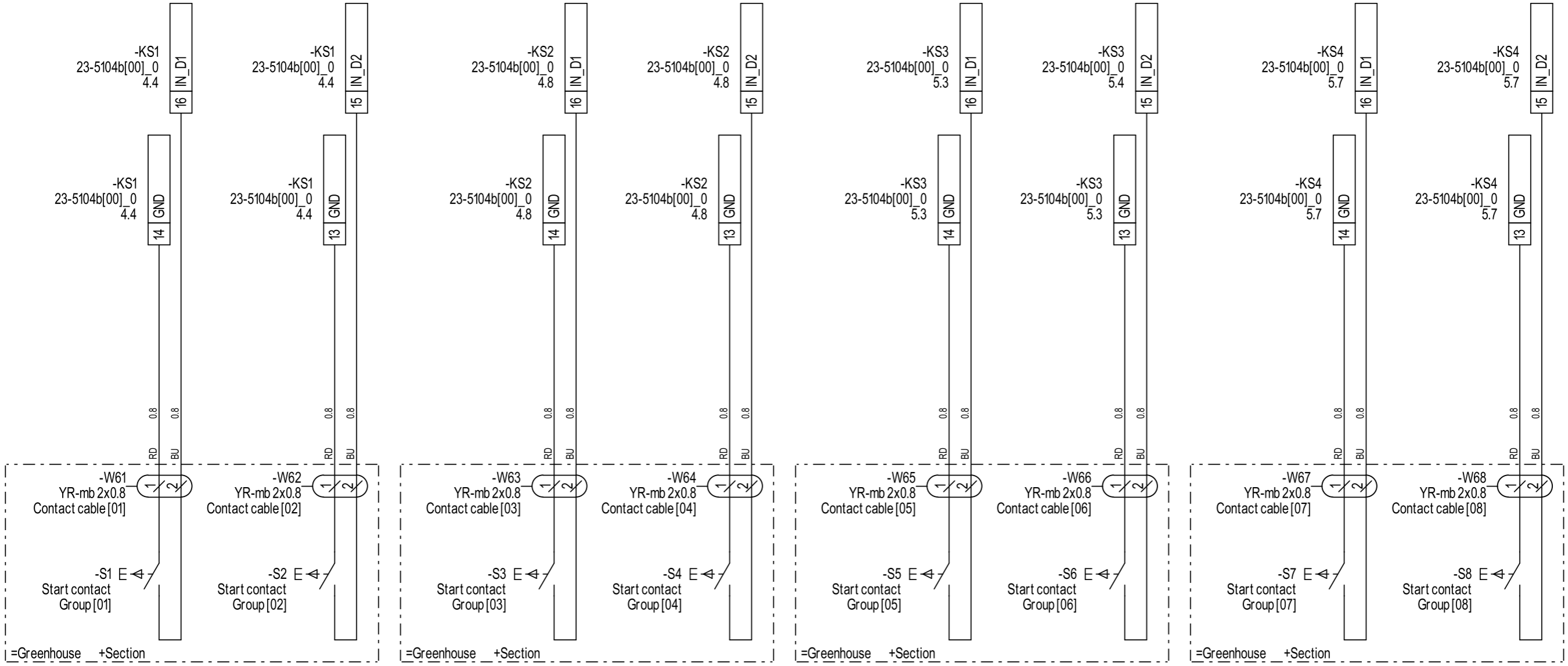

Project file:	20810101EAS020 Cabinet valve control [04] DC24V	Page initial date:	01/01/2024	Symbol scale:	1:1	Page:	10
Project number:	Function (-): =Unit	Project initial date:	01/01/2024	Page designed by:	MBL	Drawing scale:	1:1
URL:	http://www.Ridder.com	Project designed by:	MBL	Page revision date:		of:	14
Document number:	20810101EAS020	Product (-):	-Contact [S1...S8]	Page revision:		Page index:	

Customer inquiry [1] - Type of valve coils

1	Which type of valve coils are going to be controlled by the cabinet.
	The customer can opt for a specific power supply type to be installed in the cabinet. The powersupply type determines what type of valve coils can be controlled with the cabinet. What type of powersupply is to be installed in the cabinet? Register this in the table below.

-	Power supply valve coils [AC/DC]
	DC

Customer inquiry [2] - Number of controlled valves

2	What is the number of valves the customer wants to control with the cabinet.
	The number of valves to be controlled by the cabinet determines the number of Smartswitches in the cabinet. Each Smartswitch can control up to 8 valves. How many Smartswitches are to be installed in the cabinet? Register this in the table below.

#	Product code	Applied Smartswitches on_off
	20801700	Smartswitch 23-5104b[00]_0 Irrigation valve



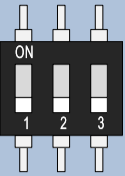
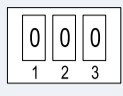
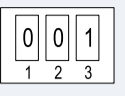
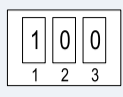
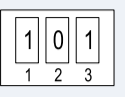
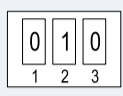
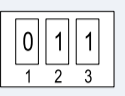
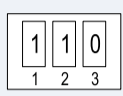
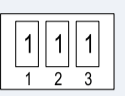

Procedure [1] - Addressing Smartswitches within the BUS-system

1	Set the section number for all Smartswitches within the BUS-system.
A	The section number is digitally composed with DIP-switches [1..3], of which DIP-switch [1] is the [Least Significant Bit], and DIP-switch [3] is the [Most Significant Bit].
1	Set the sequence number for all Smartswitches within the BUS-system.
B	The Smartswitch sequence number is digitally composed with DIP-switches [4..8], of which DIP-switch [4] is the [Least Significant Bit], and DIP-switch [8] is the [Most Significant Bit].
1	Remarks
C	The address of a Smartswitch; DIP-switches [1..8] has to be unique within the BUS-system. A Smartswitch of type [20800400 Smartswitch 24-5103b[00]_0 Alarm+meteo] always needs to be present within a BUS-system. This Smartswitch always needs to be addressed as [000 00000].

Section number - DIP-switch [1..3]

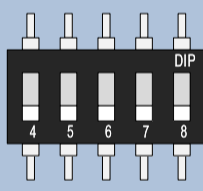
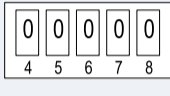
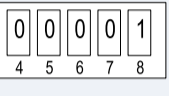
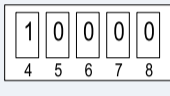
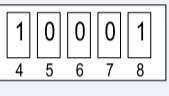
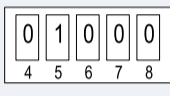
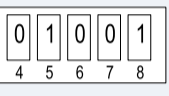
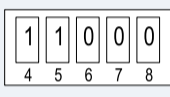
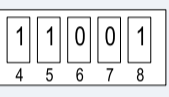
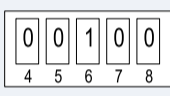
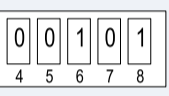
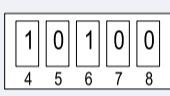
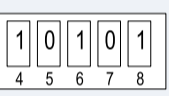
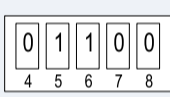
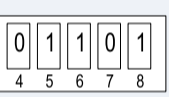
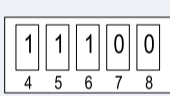
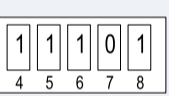
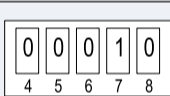
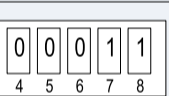
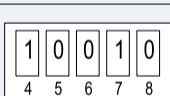
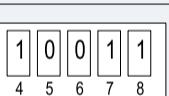
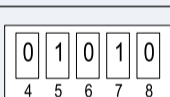
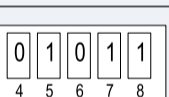
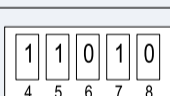
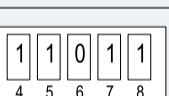
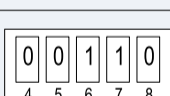
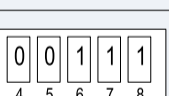
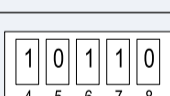
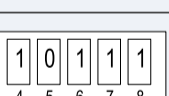
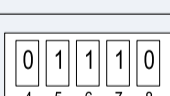
	Section 1		Section 5	
	Section 2		Section 6	
	Section 3		Section 7	
	Section 4		Section 8	

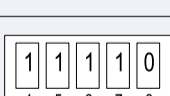
Smartswitch sequence number - DIP-switch [4..8]

	00		16	
	01		17	
	02		18	
	03		19	
	04		20	
	05		21	
	06		22	
	07		23	
	08		24	
	09		25	
	10		26	
	11		27	
	12		28	
	13		29	
	14		30	
	15		31	

Procedure [2] - Connecting cabinets within the BUS-system

2	General specifications RS485 network
A	<p>Cabinets in the network are connected in series.</p> <p>Stubs of the transmission line are not allowed.</p> <p>The [A] and [B] signals are transmitted over a twisted-pair.</p> <p>The [SGND] (Signal Ground) of the different cabinets are connected to one another over one wire of a twisted-pair.</p> <p>The [SGND] in a cabinet is connected to [PE] of that cabinet.</p> <p>The [SH] (Cable Shield) is ONLY connected to [PE] in the controller cabinet.</p> <p>The cable shields of incoming and outgoing BUS-cables in Smartswitch cabinets are spliced together and are NOT connected to [PE].</p> <p>Both the outer ends of the network have to be terminated with a 120 [Ohm] resistor.</p> <p>The maximum length of the RS485 BUS-cable in the installation is 1200 [m]. This length only applies when a suitable RS485 Bus-cable type is utilized in the installation.</p> <p>General specification for RS485 BUS-cable:</p> <ul style="list-style-type: none"> <li>• Suitable for bus systems based on RS485,</li> <li>• Twisted pair(s),</li> <li>• Shielded,</li> <li>• Characteristic impedance 120 [Ohm].</li> </ul> <p>Recommended cable types:</p> <ul style="list-style-type: none"> <li>32002810 Buskabel UNITRONIC BUS LD 2x2x0.22 100 [m]</li> <li>32002811 Buskabel UNITRONIC BUS LD 2x2x0.22 300 [m]</li> <li>32002812 Buskabel UNITRONIC BUS LD 2x2x0.22 500 [m]</li> <li>32002820 Buskabel UNITRONIC BUS LD 3x2x0.22 100 [m]</li> </ul>

Procedure [2] - Connecting cabinets within the BUS-system - Continued

2	Connecting outgoing BUS-cable to Smartswitch cabinet
E	<p>Remove resistor [R2] currently connected to terminals [A2] and [B2].</p> <p>Connect twisted pair [1] wire [WH] to terminal [A2].</p> <p>Connect twisted pair [1] wire [BN] to terminal [B2].</p> <p>Connect twisted pair [2] wire [GN] to terminal [SGND].</p> <p>Splice the cable shield of the outgoing BUS-cable together with the cable shield of the incoming BUS-cable (when present) using a splice connector. When there is no incoming BUS-cable then isolate the shield of the outgoing BUS-cable, and leave it unconnected. A BUS-cable shield should only be connected to GND at ONE outer end of that cable; in the Controller cabinet.</p> <p>When there is no outgoing BUS-cable then leave resistor [R2] in place, connected to terminals [A2] and [B2].</p>

2	Connecting incoming BUS-cable to Controller cabinet
B	<p>Remove Resistor [R1] currently connected to terminals [A1] and [B1].</p> <p>Connect twisted pair [1] wire [WH] to terminal [A1].</p> <p>Connect twisted pair [1] wire [BN] to terminal [B1].</p> <p>Connect twisted pair [2] wire [GN] to terminal [SGND].</p> <p>Connect cable shield to terminal [SH].</p> <p>When there is no incoming BUS-cable then leave resistor [R1] in place, connected to terminals [A1] and [B1].</p>

2	Connecting outgoing BUS-cable to Controller cabinet
C	<p>Remove resistor [R2] currently connected to terminals [A2] and [B2].</p> <p>Connect twisted pair [1] wire [WH] to terminal [A2].</p> <p>Connect twisted pair [1] wire [BN] to terminal [B2].</p> <p>Connect twisted pair [2] wire [GN] to terminal [SGND].</p> <p>Connect cable shield to terminal [SH].</p> <p>When there is no outgoing BUS-cable then leave resistor [R2] in place, connected to terminals [A2] and [B2].</p>

2	Connecting incoming BUS-cable to Smartswitch cabinet
D	<p>Remove Resistor [R1] currently connected to terminals [A1] and [B1].</p> <p>Connect twisted pair [1] wire [WH] to terminal [A1].</p> <p>Connect twisted pair [1] wire [BN] to terminal [B1].</p> <p>Connect twisted pair [2] wire [GN] to terminal [SGND].</p> <p>Splice the cable shield of the incoming BUS-cable together with the cable shield of the outgoing BUS-cable (when present) using a splice connector. When there is no outgoing BUS-cable then isolate the shield of the incoming BUS-cable, and leave it unconnected. A BUS-cable shield should only be connected to GND at ONE outer end of that cable; in the Controller cabinet.</p> <p>When there is no incoming BUS-cable then leave resistor [R1] in place, connected to terminals [A1] and [B1].</p>

Network topology

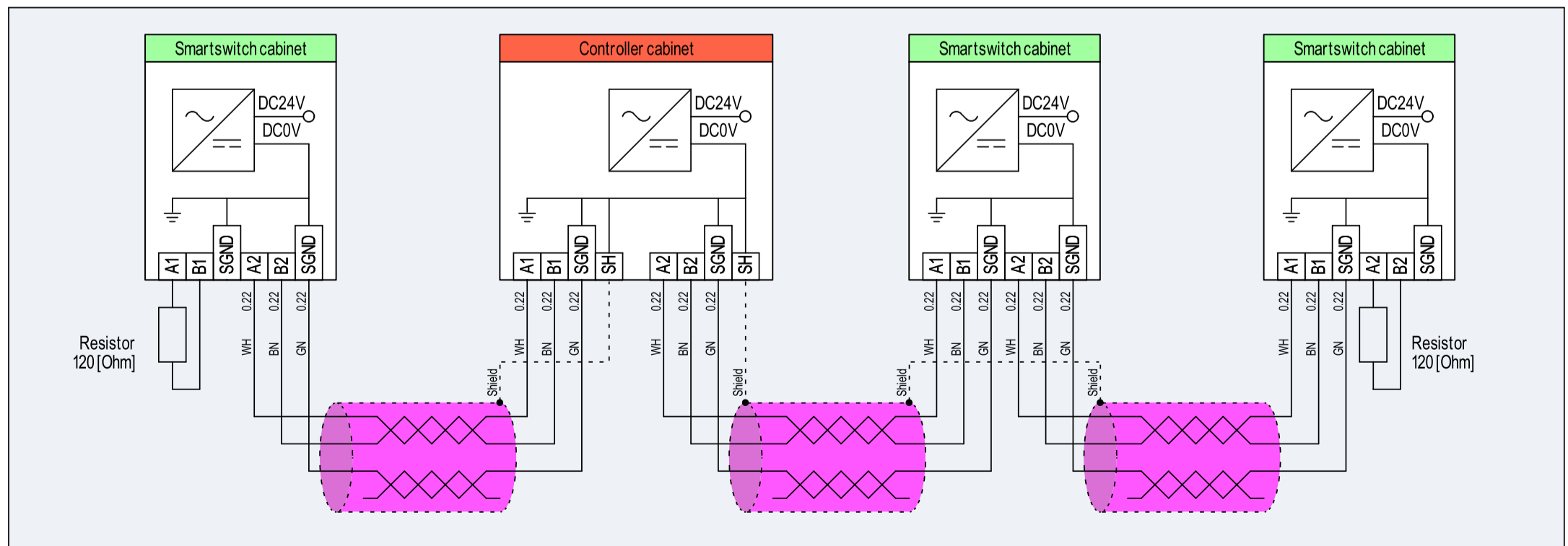

TERMINALBLOCKEN		TERMINALBLOCKEN	
NO.	NAAM	NO.	NAAM
1		2	
3		4	
5		6	
7		8	
9		10	
11		12	
13		14	
15		16	
17		18	
19		20	
21		22	
23		24	
25		26	
27		28	
29		30	
31		32	
33		34	
35		36	
37		38	
39		40	
41		42	
43		44	
45		46	
47		48	
49		50	
51		52	
53		54	
55		56	
57		58	
59		60	
61		62	
63		64	
65		66	
67		68	
69		70	
71		72	
73		74	
75		76	
77		78	
79		80	
81		82	
83		84	
85		86	
87		88	
89		90	
91		92	
93		94	
95		96	
97		98	
99		100	

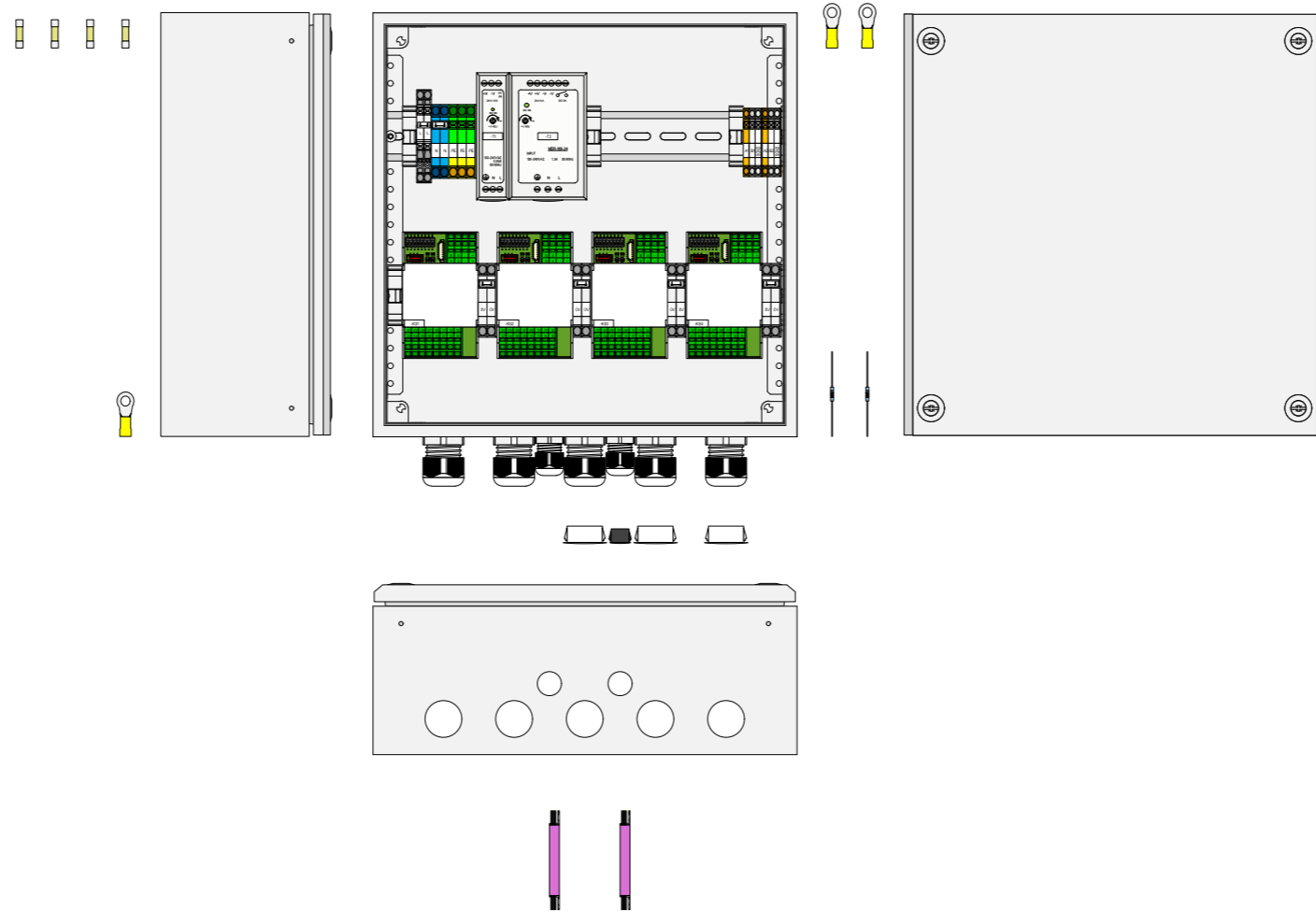

Project file:	20810101EAS020 Cabinet valve control [04] DC24V			Page initial date:	01/01/2024	Symbol scale:	1:5	Page:	14
Project number:	Function (-): =Unit			Project initial date:	01/01/2024	Page designed by:	MBL	Drawing scale:	1:5
URL:	http://www.Ridder.com			Project designed by:	MBL	Page revision date:		of:	14
Document number:	20810101EAS020			Project status:	[As Build]	Page revision:		Page index:	
	Location (+): +Main cabinet								
	Product (-): -Cabinet layout								